

BOSS
SUSPENSION



USER MANUAL

WARRANTY



Terms and conditions

BOS Suspension offers warranty on its products on the following terms:

BOS guarantees to the original purchaser that the BOS product for which they received this warranty is free from defects in material and workmanship for one year from the date of original retail purchase. A proof of purchase will be asked for any warranty claim. This warranty is not transferable to a subsequent purchaser.

Wear and tear parts such as dust seals, O-rings, bushings, rear shock mounting hardware, stanchions, threaded parts and bolts are not covered under this warranty.

Terms

This warranty is subject to legal jurisdictional or warranty rights of the country where it has been originally purchased, which will prevail if different from the terms herein listed.

Limits

BOS Suspension cannot be liable for any loss, inconvenience damages, whether direct, incidental, consequential, resulting from the use of its products, local legislation prevailing.

Warranty exclusions

This warranty does not cover the following cases:

- Damage to products resulting from improper assembly other than listed below
- Products that have been modified by the owner or a third party
- Improper use
- Damages resulting from an accident or a crash under any circumstances
- Invalid servicing procedures and servicing time frame not respected
- Replacement of the original parts by parts from others manufacturers
- Products whose serial numbers has been altered, defaced or removed.

Warranty procedure

The owner should always refer to an approved BOS service center for any warranty claim. A proof a purchase is compulsory for any warranty claim. Otherwise the warranty claim will not be considered. Always contact BOS Suspension warranty department before returning any products that may fall under this warranty. If "the faulty parts" do not fall under warranty, the customer will be charged for any costs in respect with warranty such as transport and package back and forth.

1. Assembly

Fitting your Deville onto your bike requires care and attention. For your safety, please follow these instructions.

1.1 The steer tube

Before cutting the steer tube, first take some measurements: height of the headset, length of the frame's head tube, height of the stem and then add 5 to 10mm.

Calculate the length as below:

Length of the head tube of the frame + height of the headset + height of the stem + 5 to 10mm.

Caution :

Never attempt to remove or replace the steer tube or stanchions independently from the crown. Modifying the integrated crown, steer tube, or stanchions can cause an assembly failure, resulting in a loss of control of the bicycle and serious injury.

1.2 Installing the front wheel: 20mm or 15mm axle

To assemble the front wheel, follow this procedure:

1. Open the quick release on right side of the fork (1).
2. Open the thru-axle's folding lever (2)
3. Unscrew the axle and remove it (3).
4. Install the wheel.
5. Insert the axle and screw it completely. Fold the lever. Close the quick release.

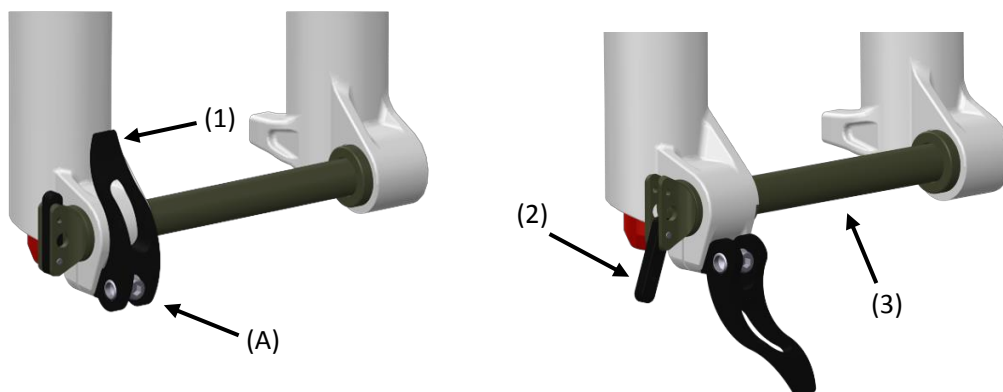

To disassemble the wheel, follow these instructions in reverse.

Important :

The torque of the QR screw (A) is originally set between 4 and 4.5n.m. It is useful to check it regularly.

1.3 Disassembling the 15mm axle adapter to use the 20mm axle

The transition from the 15mm to the 20mm axle requires the disassembling of an adapter sleeve on the left leg. To disassemble the adapter, proceed as follows:

1. Unscrew the adapter, if necessary slightly warm the left leg and the insert (1) with heat gun.
2. Remove the leftover LOCTITE from the threads
3. Refer to section 1.2 for the 20mm axle wheel mounting.

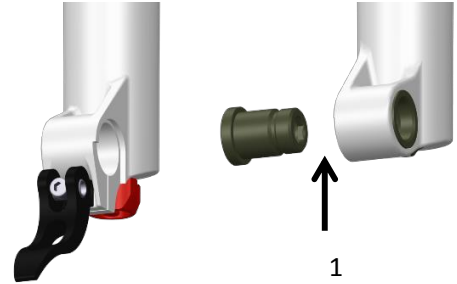

1.3. Mounting the 15mm axle adapter sleeve

The transition from the 20mm to the 15mm axle requires the mounting of an adapter sleeve on the left leg. To assemble the adapter, proceed as follows:

1. Add a drop of LOCTITE 243 to the adaptor threads and Hand-tighten the 15mm adapter (1).
2. Tighten up to the torque 12N.m.
3. Refer to section 1.2 for the 15mm axle wheel mounting.

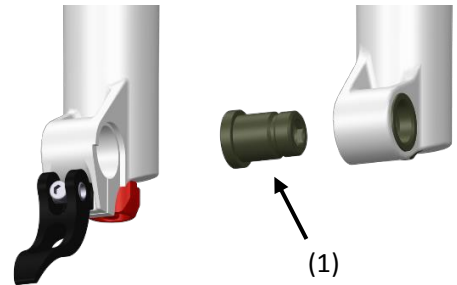

1.4. Brake caliper installation

The Deville brake caliper bolt pattern uses post mount 160 (PM160).

To assemble the disc brakes, follow this procedure:

1. Install the disc brake caliper, according to disc brake manufacturer's specifications.
2. Be sure to torque all fasteners and bolts to manufacturer's recommendations. Consult the instructions that came with your disc brakes for proper installation procedures. It is recommended to install new brake pads, to ensure proper alignment.
3. Route the disc brake hose or cable housing from the caliper to the inside of the lower leg and through the supplied disc brake hose guide.
4. Test the brakes for proper operation on level ground before hitting the trails.

The disc brake caliper mounting bolts must have 10 mm of thread engagement with the fork.

The disc brake caliper mounting bolt tightening torque level must never exceed 10 n.m.

2. Settings

2.1 Air Spring

The first adjustment that should be done on the fork is to set the air pressure. This adjusts the stiffness of the air spring according to your weight. The stiffness of the air spring induces a degree of fork travel when you sit on your bike. This value, commonly called sag, can vary based on your usage. This value should be between 24mm (smooth terrain/climbs) and 40mm (rough terrain/downhills) for the 160mm Deville and between 26mm (smooth terrain/climbs) and 42mm (rough terrain/downhills) for the 170mm Deville. The sag measurement should be taken with both feet on the pedals and both hands on the bars, arms and legs in the pedaling position. The Deville has an o-ring on the fork upper tube in order to measure the SAG position. You can experiment and vary your sag percentage to better suit your riding style and overall feel.

To achieve the best performance from your BOS product, it is important to set your optimal pressure. **The chart below will give you some base values based on your weight. Your specific pressure may vary based on your riding style and personal preference.** However, do not stray too far from the indicated pressures, or you may risk changing the performance of your fork.



It's recommended to use our BOS high pressure pump with a digital manometer more accuracy and comfortable to use, available on our website: <http://boutique.bosmtb.com/>

Recreational use :

| | | | | | | | | | | |
|--------------------|--------|--------|--------|--------|--------|--------|--------|--------|---------|---------|
| Weight (Kg/lbs) | 55/120 | 60/132 | 65/143 | 70/154 | 75/165 | 80/176 | 85/187 | 95/210 | 105/132 | 110/242 |
| Air pressure (psi) | 50 | 60 | 65 | 75 | 80 | 90 | 95 | 105 | 110 | 120 |

Racing use :

| | | | | | | | | | | |
|--------------------|--------|--------|--------|--------|--------|--------|--------|--------|---------|---------|
| Weight (Kg/lbs) | 55/120 | 60/132 | 65/143 | 70/154 | 75/165 | 80/176 | 85/187 | 95/210 | 105/132 | 110/242 |
| Air pressure (psi) | 55 | 65 | 70 | 80 | 85 | 95 | 100 | 110 | 115 | 125 |

Caution :

Minimum air pressure : 45 psi
Maximum air pressure : 130 psi

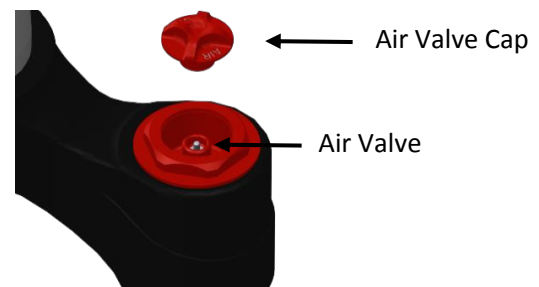

Important :

Balancing the air chamber pressure:

It is important to balance the positive and negative chambers to ensure optimum operation of the fork every time you adjust the pressure.

Proceed as follows:

After adjusting the pressure, cycle the fork slowly 3-4 times on the first inch of travel.

Thus, the air pressure is distributed equally between the chambers, and your fork is ready to roll.

2.2 TRC Option

On Deville TRC models, the TRC “ON” position increases the stiffness of the fork by reducing the air chamber volume. This system allows you to keep the balance of the bike, especially in downhill and to reduce the effects of pedaling. Hydraulic function of the fork function remains the same.

| TRC <OFF> | TRC <ON> |
|--------------------------|----------------------------|
| Lever position: forward | Lever position: backward |
| Spring curve: standard | Spring curve: ramping |
| Use: normal and climbing | Use: downhill and pedaling |

Important :

You can adjust the position of the TRC lever in case it touches your frame or for better handling.

Proceed as follows:

- remove the valve cap.
- Extract the lever.
- Replace it at the required position.

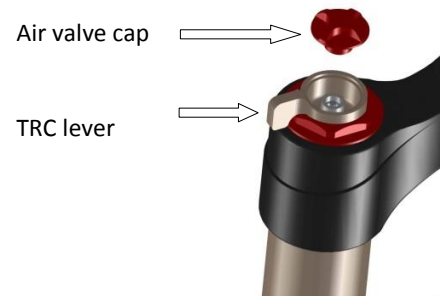

2.3 Hydraulic adjustments

The Deville offers 3 hydraulic adjustments: low-speed compression, high-speed compression, and rebound.

Rebound adjustment is done by rotating the silver knob at the top of the right fork leg (1).

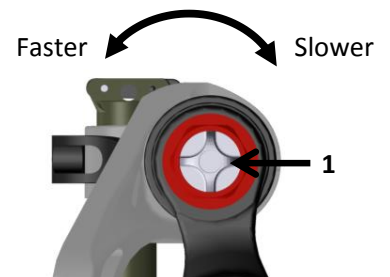

Low-speed compression is adjusted with the silver knob at the bottom of the right fork leg (2-A).

High-speed compression is adjusted with the red knob at the bottom of the right fork leg (2-B).

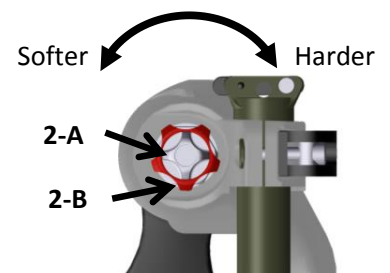

IMPORTANT

To start setting your suspension adjustment, turn the knob all the way in the clockwise direction (=click 0) then turn your adjuster counterclockwise one click at a time.

Tuning tips:

When it comes to hydraulic settings, there is no such thing as a magical formula; many factors have to be taken into account (bike balance, spring rate, bike geometry, and rider preferences to name a few). Having said that, the following may help guide your adjustments:

- Excessive diving of the fork under hard braking: Harden the LS compression
- Often bottom out: Harden the HS compression
- Feeling harsh on roots or square edges: Soften HS compression

- Uncomfortable, arms feeling sore: Slow down rebound
- The forks don't spring back and stays low after succession of bumps: Speed up rebound
- Front too high (in dynamic situation): Harden the rebound

Whenever you are far from the standard settings (factory settings), it's always good to consider what influences the performance of the fork. Proceed step by step, one setting at a time by hardening or softening just a few clicks each time. If you ever get lost while you are setting up the forks, always go back to its original settings.

Starting point adjustments – Deville

The number of clicks is counted from the fully closed position while unscrewing the knob.

Harder = tighten (close in the clockwise direction)

Softer = loosen (open in the counterclockwise direction)

Recreational Use

Low-speed compression: 15 clicks

High-speed compression: 15 clicks

Rebound: 15 clicks

Racing Use

Low-speed compression: 10 clicks

High-speed compression: 18 clicks

Rebound: 14 clicks

3. Maintenance

3.1. Service

It is compulsory to clean your forks immediately after every use! Nothing is worse for your fork's seals than dirt and dust.

It is very simple to clean your forks: wipe off the stanchion with a clean rag and then slightly lube the stanchion (with fork oil).

Warning: Do not under any circumstances use degreaser.

On the same note, do not power wash the forks! It will only push the mud inside the forks and get it stuck between the stanchion and the seals.

| Item | | New | Every ride | Every 6 months | Every year | Every two years |
|---------------------|----------------------|-----|------------|----------------|------------|-----------------|
| Set sag | | x | | | | |
| Set adjustments | | x | | | | |
| Clean fork exterior | | | x | | | |
| Basic Service | Wet/Muddy conditions | | | x | | |
| | Racing/frequent use | | | x | | |
| | Dry/dusty conditions | | | | x | |
| Complete service | Wet/Muddy conditions | | | | x | |
| | Racing/frequent use | | | | x | |
| | Dry/dusty conditions | | | | | x |
| Inspect Bushings | Wet/Muddy conditions | | | | x | |
| | Racing/frequent use | | | x | | |
| | Dry/dusty conditions | | | | | x |

Caution :

The oil service and full service should be performed by a BOS-approved service center. Only BOS service centers are able to identify and appraise a damaged or worn part, especially in case of shock or wear on structural elements such as the legs, the stanchions and the crowns.

Refer to technical documents on the BOS website for all maintenance guides out of BOS service center.

3.2 Oil Height

When changing the oil, make sure that you set the oil height and volume correctly on the spring side as well as the hydraulic side of your fork.

Caution :

To correctly set the oil height, purge the cartridge by working it through its travel as you add oil. Once the cartridge is completely purged of air, you can set your oil height.

The oil height is measured as follows:

- Push the stanchions down completely.
- Pull the rebound shaft up to its maximum height.
- Measure the distance from the top of the crown to the oil with a clean ruler (A)

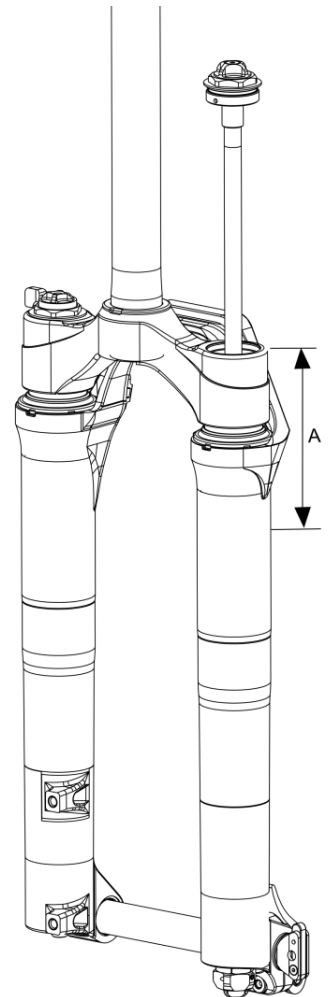

Deville Oil Levels

| | Deville 140 | Deville 150 | Deville 160 | Deville 170 |
|------------------------|-------------|-------------|-------------|-------------|
| Hydraulic side (right) | 60mm | 70mm | 75mm | 79mm |
| Spring side (left) | 5ml | 5ml | 5ml | 5ml |

Always add the oil to the air spring directly into the lowers from underneath the fork and not into the air shaft or in the air piston.

Important :

It is strongly recommended to use BOS Bi'oil to prevent damage to internal seals and to maintain the fork's performance .

My fork loses pressure when I remove the pump, what can I do?

Check the valve core tightness using a Schrader valve core tool.

My fork has negative travel, is this normal?

The BOS air spring is designed to lower the engagement threshold as much as possible. Therefore, it is possible on some bikes that there will be a small negative travel.

Where can I buy replacement stickers or a valve cap?

These items and more are available in our online store.

My new fork has bushing play, what should I do?

The unique bushing alignment and tolerance on BOS forks results in less friction, more sensitivity, and some bushing play from the factory. If the bushing play feels abnormally excessive, please contact a BOS service center for help.

My fork is lowering as I deflate it, what is happening?

When you deflate the fork by the Schrader valve, you are only emptying the positive air chamber. The negative air chamber stays under pressure and exerts an opposing force on the air piston and pulls the fork down. To avoid this phenomenon, deflate the fork in steps of 30-40 PSI and equalize the air chambers between steps (compress and release the fork 5-10 times over the first 20mm – 1 inch) of travel.

I just inflated my fork for the first time and it is really hard, what can I do?

Have you equalized your fork's air chambers? If not, check how it's done in the setup section of your product's user manual.

Did you change your fork's settings? Check that your low-speed and high-speed compression are at our recommended base settings given in the setup section of your product's user manual.

If you've equalized your fork, you may have some internal pressure from the production process. You can eliminate this pressure by slipping a thin ziptie between your left dust seal and your stanchion until you hear the sound of air escaping. Then reset your pressure and equalize your air chambers.

If you've tried all that and your fork is still hard, email customer service and they'll give you a hand.

My fork was upside down or on its side and now it feels like there's no hydraulic control.

Your cartridge has depurged – air has entered the hydraulic system. Open bath cartridges like the one used in your fork allow air to mix with oil. The cartridge purges itself as you ride. You can purge the fork even faster by cycling it through its full travel 5-10 times.

If it is becoming increasingly difficult to purge your cartridge, it may be time for an oil change. Contact your closest BOS authorized service center for a basic or a full service.

I have about 5mm of travel unused when I ride normally.

Our forks are designed to be very progressive at the end of travel to give you a bottomless feeling. This means that those last couple millimeters of travel might only be used on the biggest hits or when you case a landing. You can think of them as insurance to get you out of the trickiest situations. If you have more than about 5% of your travel unused, try lowering your air pressure by 5PSI and check your compression settings. If your compression settings are much harder than our recommended values, try bringing them closer to the base settings in your product's user manual.

I have grease/oil coming out of my brand new fork seals.

This is not unusual at the beginning of the life of a fork. Clean off the stanchions and the seals and it will stop after a few rides.

My fork has been sitting for a couple of weeks and some oil came out of the seal when I rode it the first time.

BOS seals can let out a little bit of oil when they have been sitting and dried out. Wipe off any oil, and none more will come out when the seal is lubricated again.

I have grease/oil coming out of my well-ridden fork seals.

It’s time for a service! Contact your nearest BOS authorized service center for a full service.

But I haven’t reached your recommended service interval yet

Our recommended service intervals cannot cover 100% of customer’s usage cases. Use in wet, muddy conditions; storage out in the sun; frequent use; or improper care can all cause your seals to wear out more quickly.

Where can I find my serial number?

The serial number is engraved under the steer tube, it’s composed of 7 numbers.

How can I adjust my FCV?

The FCV is a very precise, internal system who is preset in our factory.

I’ve no been completely successful in doing my own adjustments. What can I do?

The internal tuning (settings/FCV/air damper) is tuned at the factory to correspond to most riders, however it’s possible to adapt all of these parameters to match with your weight, your use and your style. Even so, to optimize your set up please contact your BOS service center.

For any other questions, please visit our FAQ page on the BOS website or send us a message to customerservice@bosmtb.com

5 .Notes

| Date | Location | Air pressure (Psi) | HS Compression | LS Compression | Rebond | Remarks |
|------|----------|--------------------|----------------|----------------|--------|---------|
| | | | | | | |
| | | | | | | |
| | | | | | | |
| | | | | | | |
| | | | | | | |
| | | | | | | |
| | | | | | | |
| | | | | | | |
| | | | | | | |
| | | | | | | |
| | | | | | | |
| | | | | | | |
| | | | | | | |
| | | | | | | |
| | | | | | | |
| | | | | | | |
| | | | | | | |
| | | | | | | |
| | | | | | | |
| | | | | | | |
| | | | | | | |